

Fire music WIFI
Aroma Diffuser

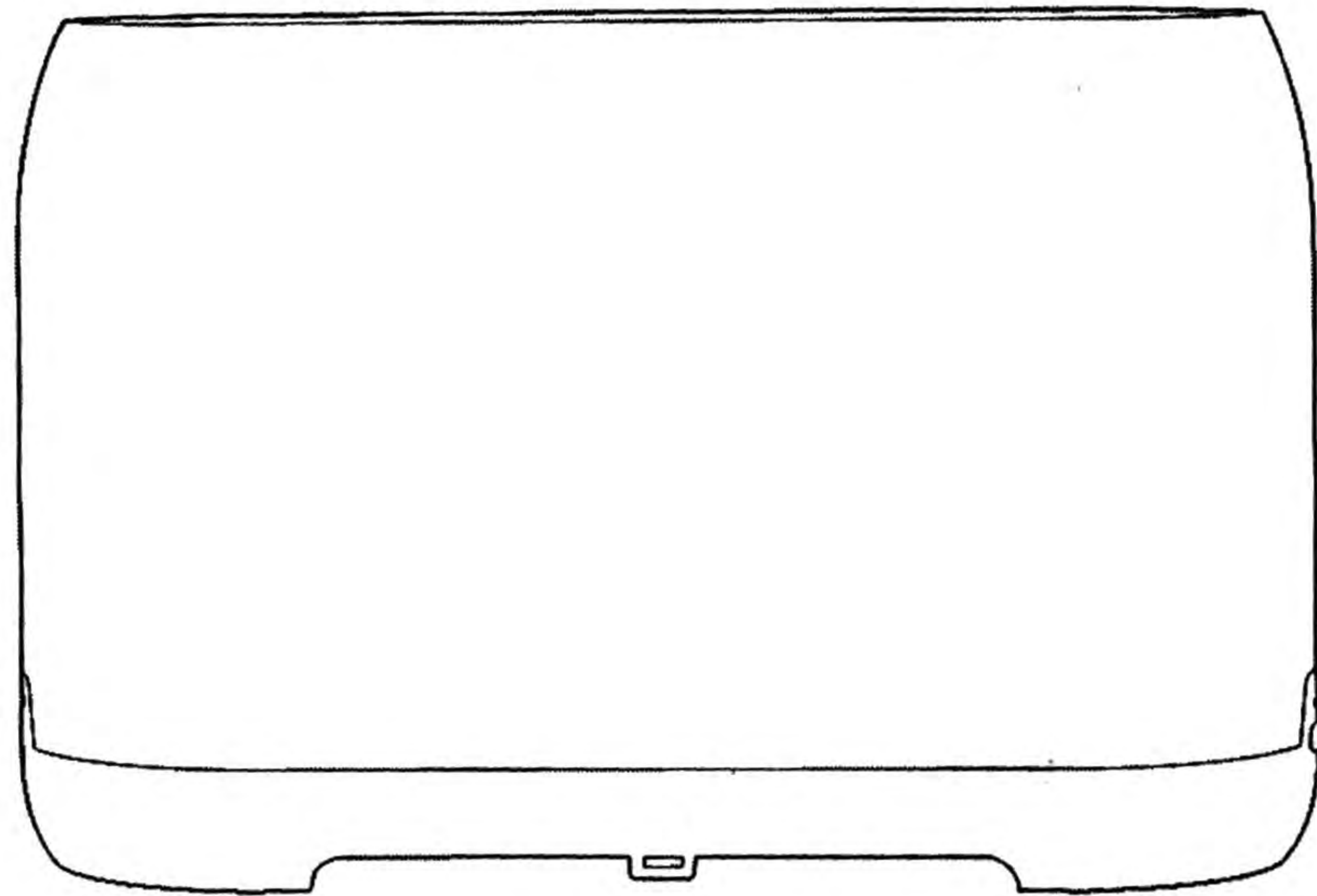

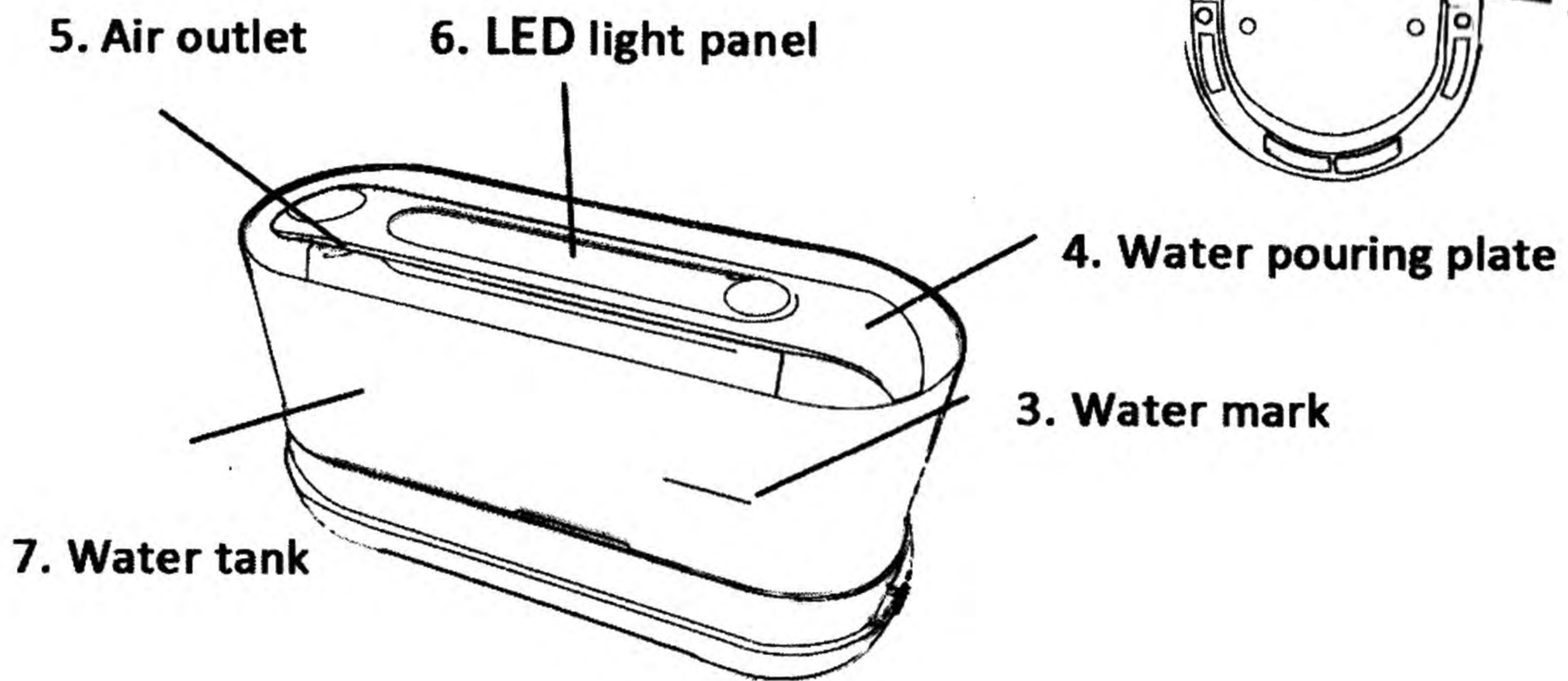
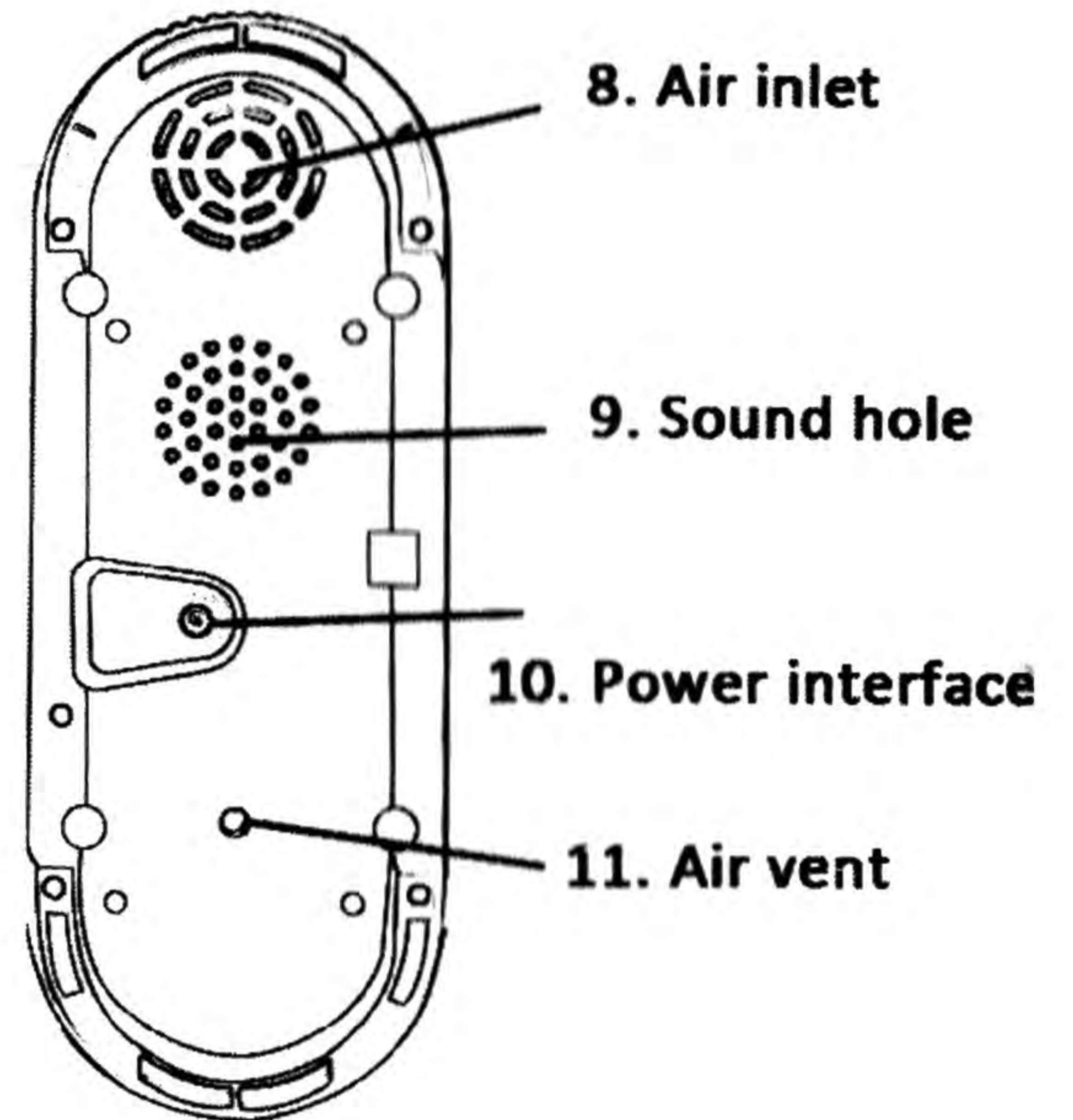
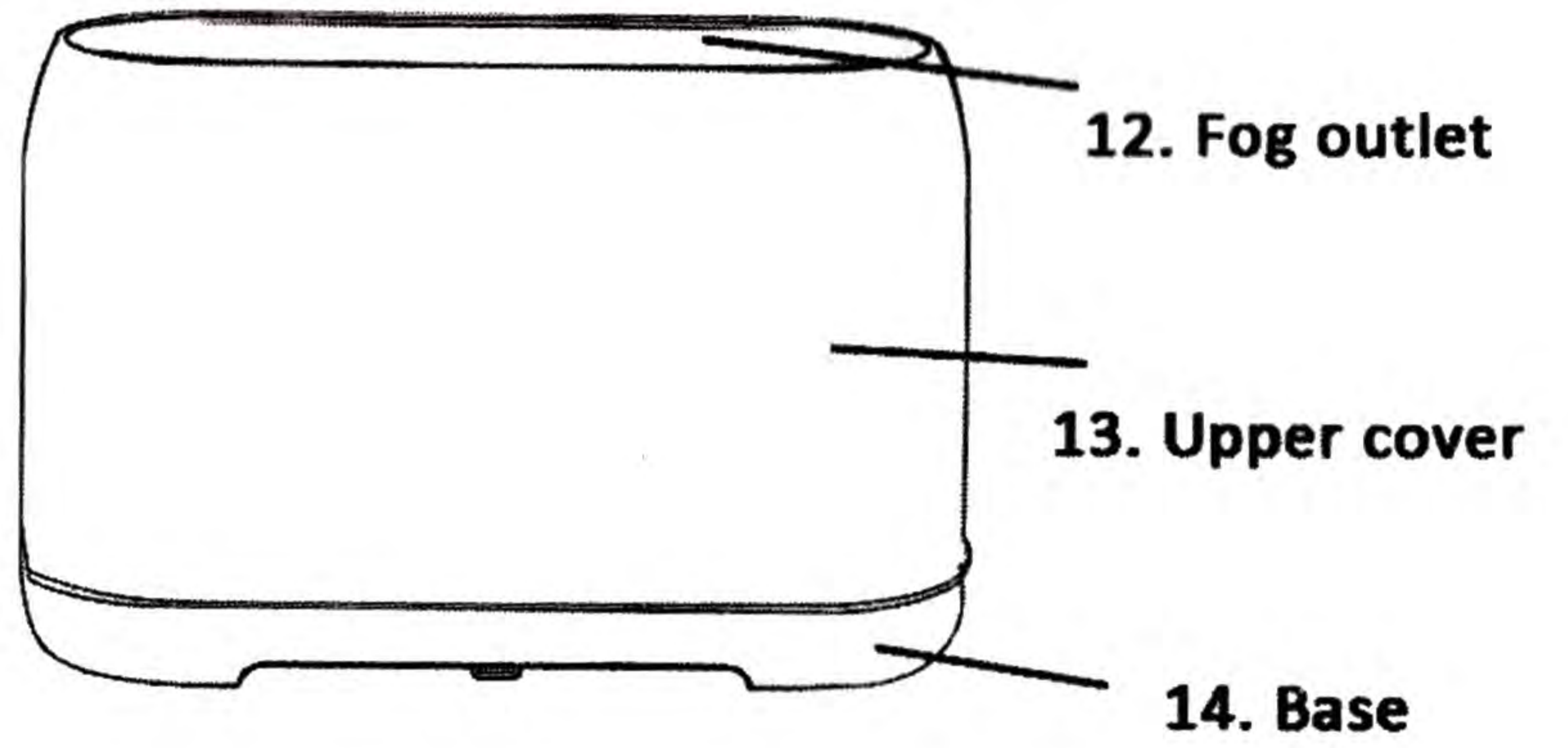
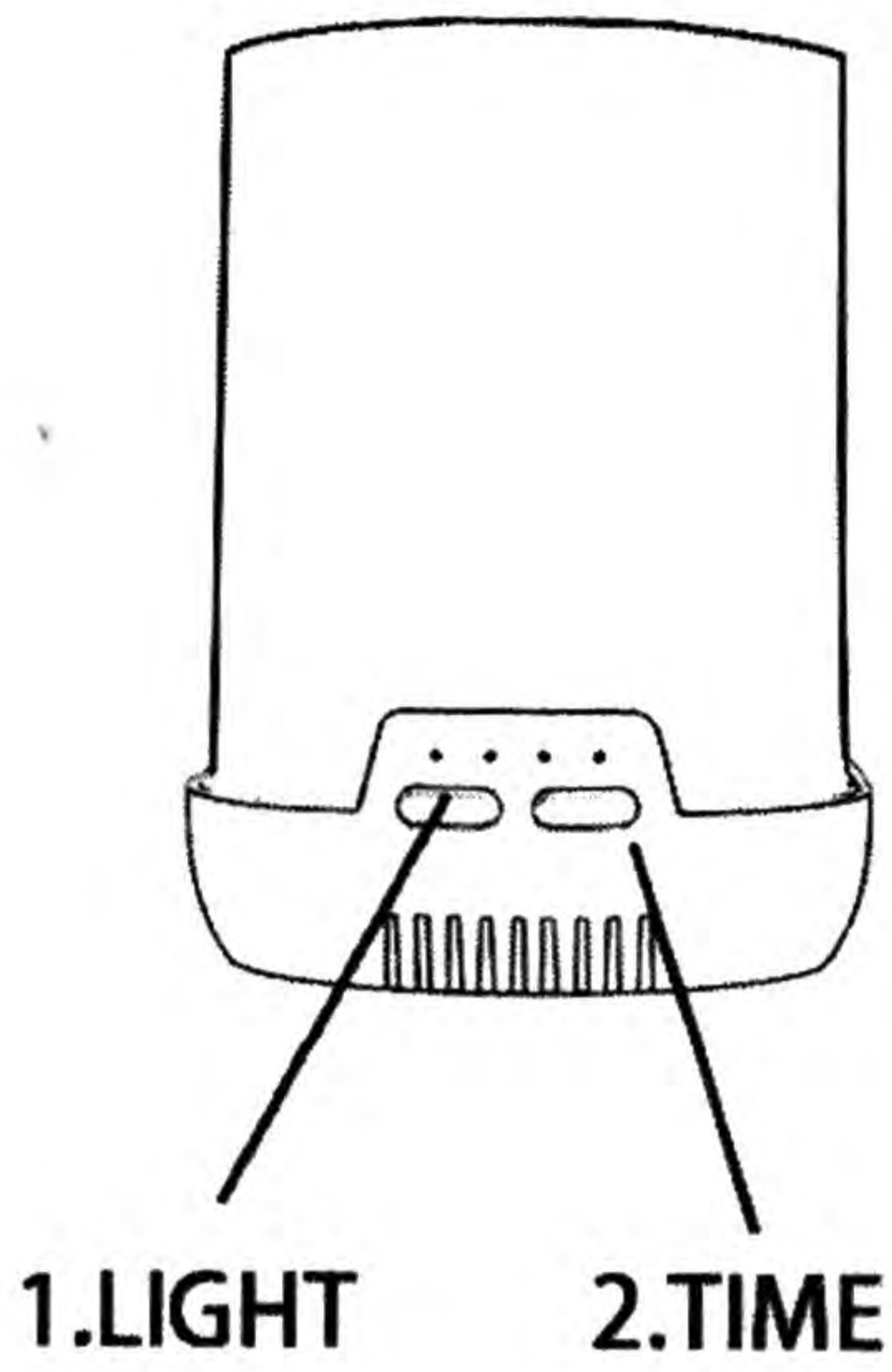

Diffuser function

1. Place the aromatic diffuser vertically and pull it up vertically to remove the cover. (Figure 1)

2. Connect the AC adapter power cord to the aromatic diffuser. It is recommended to lay the cable through the provided track. (Figure 2)

3. Pour water and essential oil into the aromatic diffuser.

Do not fill more than 350 ml of the MAX mark. Do not use boiling water. Do not fill when power is on. It is recommended to add 2-3 drops of essential oil every 100ml of water. (Figure 3)

4. Reinstall the cover. The nozzle can be adjusted to guide the fragrance to the desired direction.

Aromatic diffuser

Do not operate without a cover. (Figure 4)

5. Insert the diffuser into the power socket.

6. Briefly press the color light function of the "LIGHT" button. Long press the "LIGHT" button for Bluetooth music function (the first indicator light is on, indicating that Bluetooth is being linked): (Figure 5)

1) Press "LIGHT" to turn on the LED. Turn on the flame light. (Figure 5)

2) Press the light button again to start RGB color mode, press the light button again to freeze RGB color, and press the light button again to turn off the flame light. (Figure 5)

7. Briefly press the "MIST" button to start the timing mode, and long press the "MIST" button (App pairing button) to pair WIFI through the mobile phone Tuya APP: (Figure 6)

1) Timing function: the third and fourth indicator conditions 2H/3H/6H timing mode can be used. (Figure 6)

2) WIFI pairing function: long press the "MIST" button, and the WIFI connection mode is on. (The second indicator will flash, indicating that the device is being searched) (Figure 6)

8. It is recommended that the water in the water tank be drained and kept dry to extend the idle time.

9. When the power is turned on, the original state of the aroma diffuser is still closed.

10. When the water is insufficient, the fogging operation and the light will automatically turn off. Even if you press "LIGHT" for a long time, the aroma diffuser will also turn off automatically. (Figure 5)

11. Indicator light description: the first indicator light "permanently on" indicates that Bluetooth is enabled; "off" indicates that Bluetooth is disabled. The second indicator light "permanently on" indicates that WIFI connection is successful; "off" indicates that WIFI is not connected; "flashing" indicates that WIFI networking is in progress.

The third indicator light is 2H timing function, the fourth indicator light is 4H timing function, and the third and fourth indicators light up simultaneously for 6H timing function.

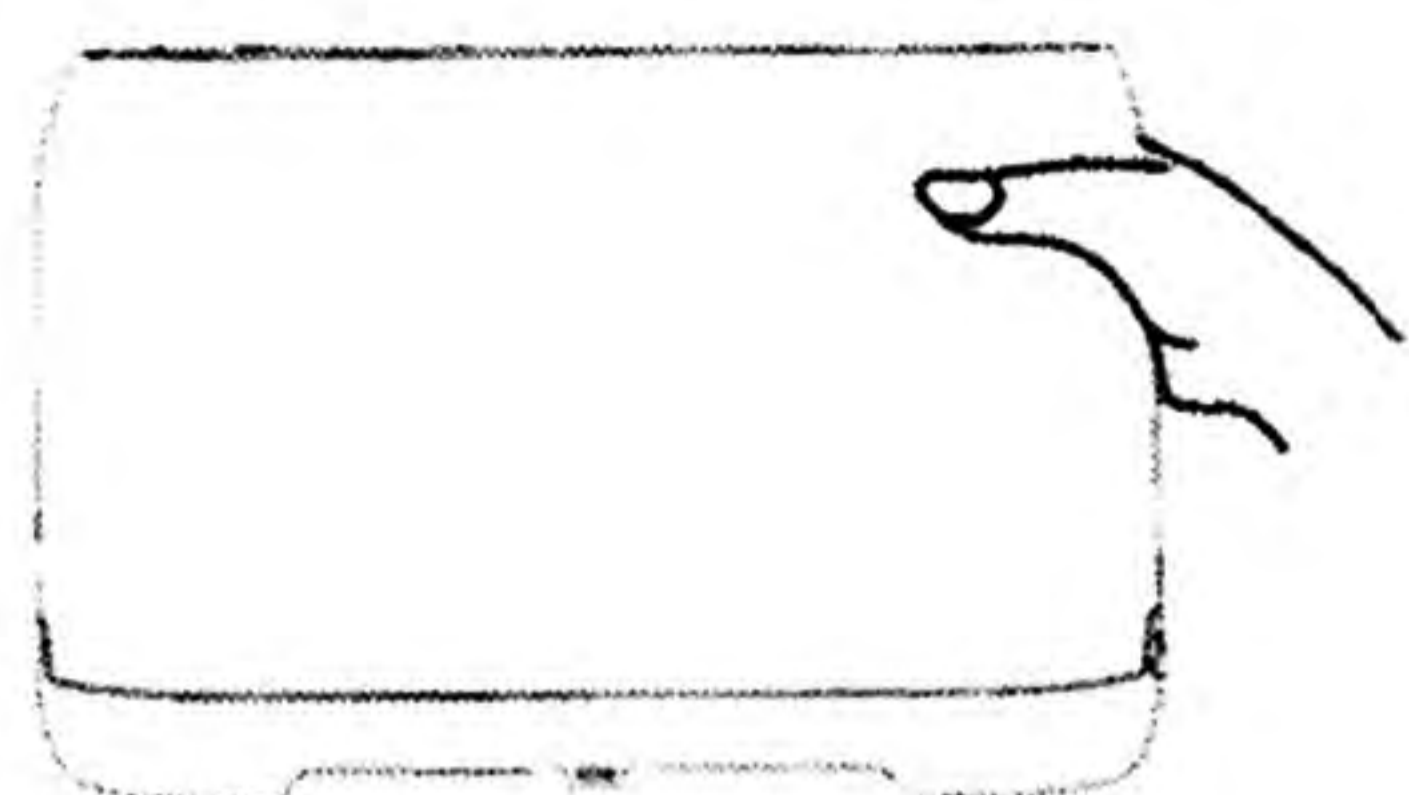

Fig1

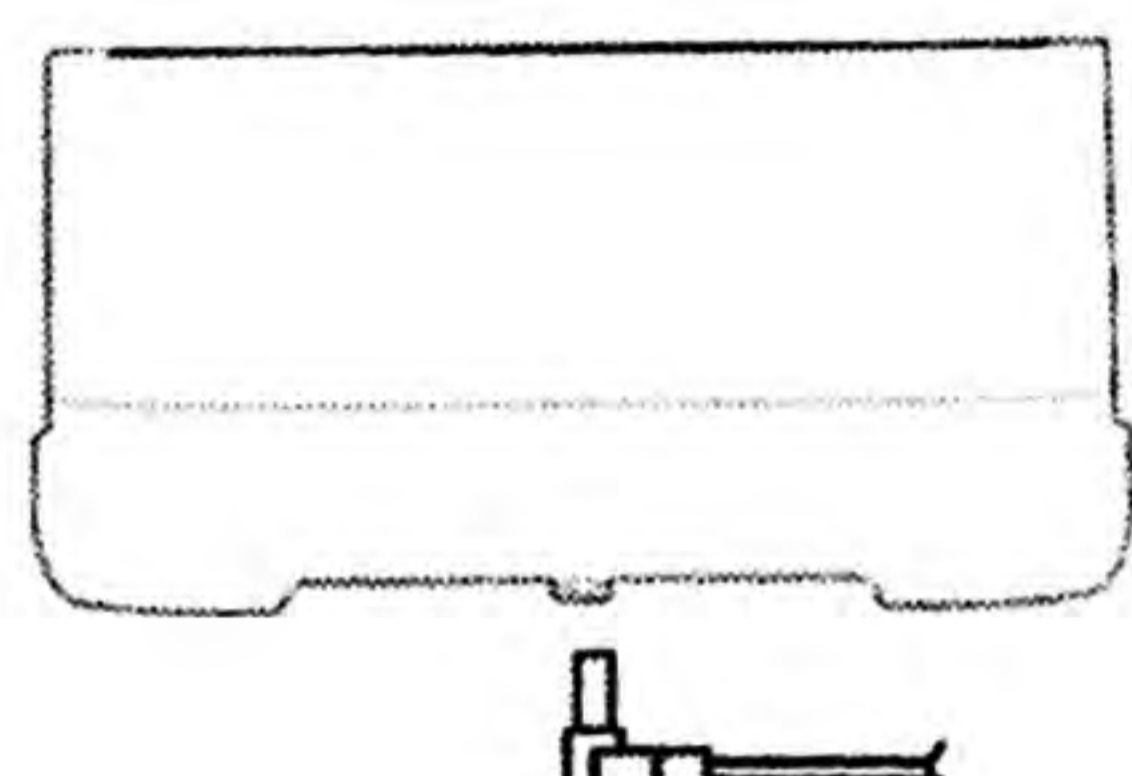

Fig2

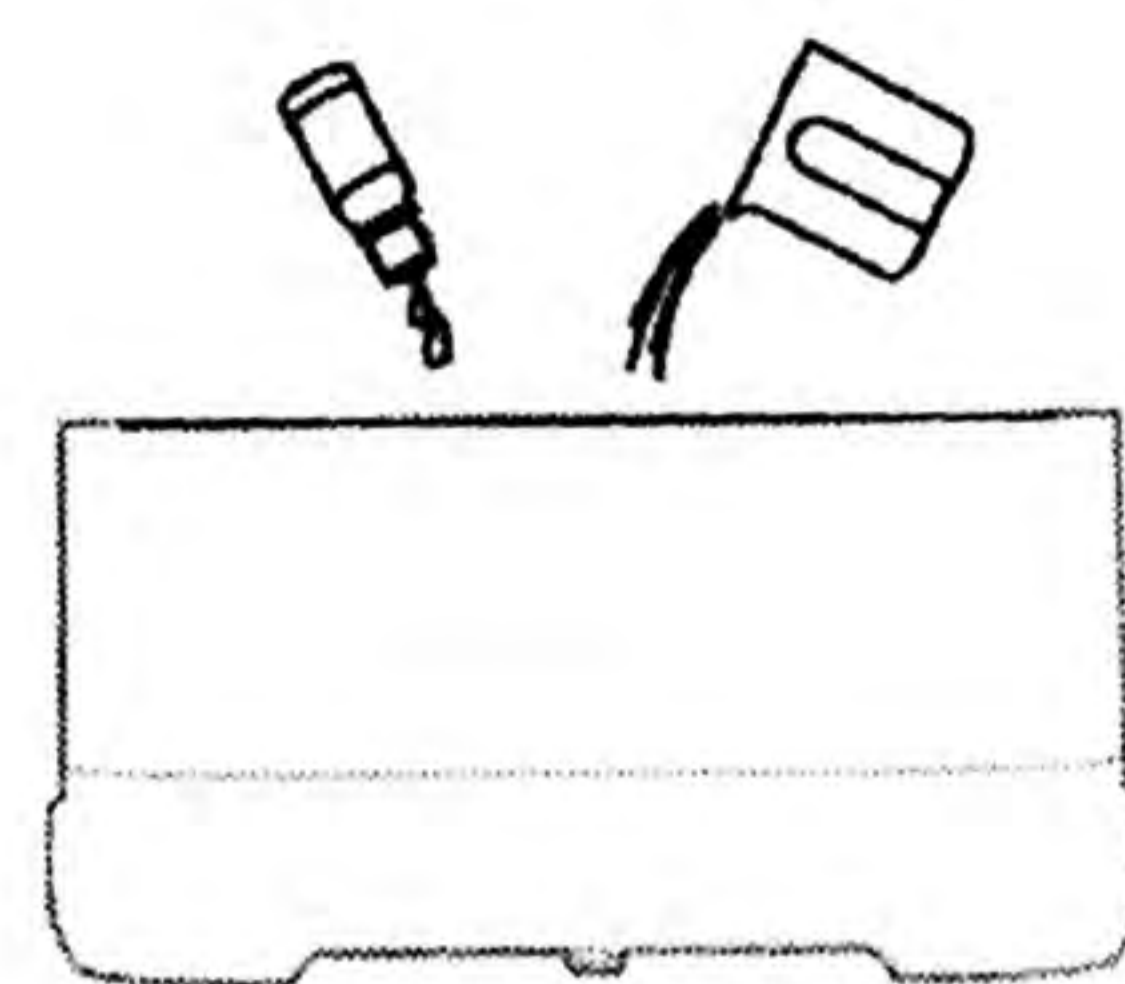

Fig3

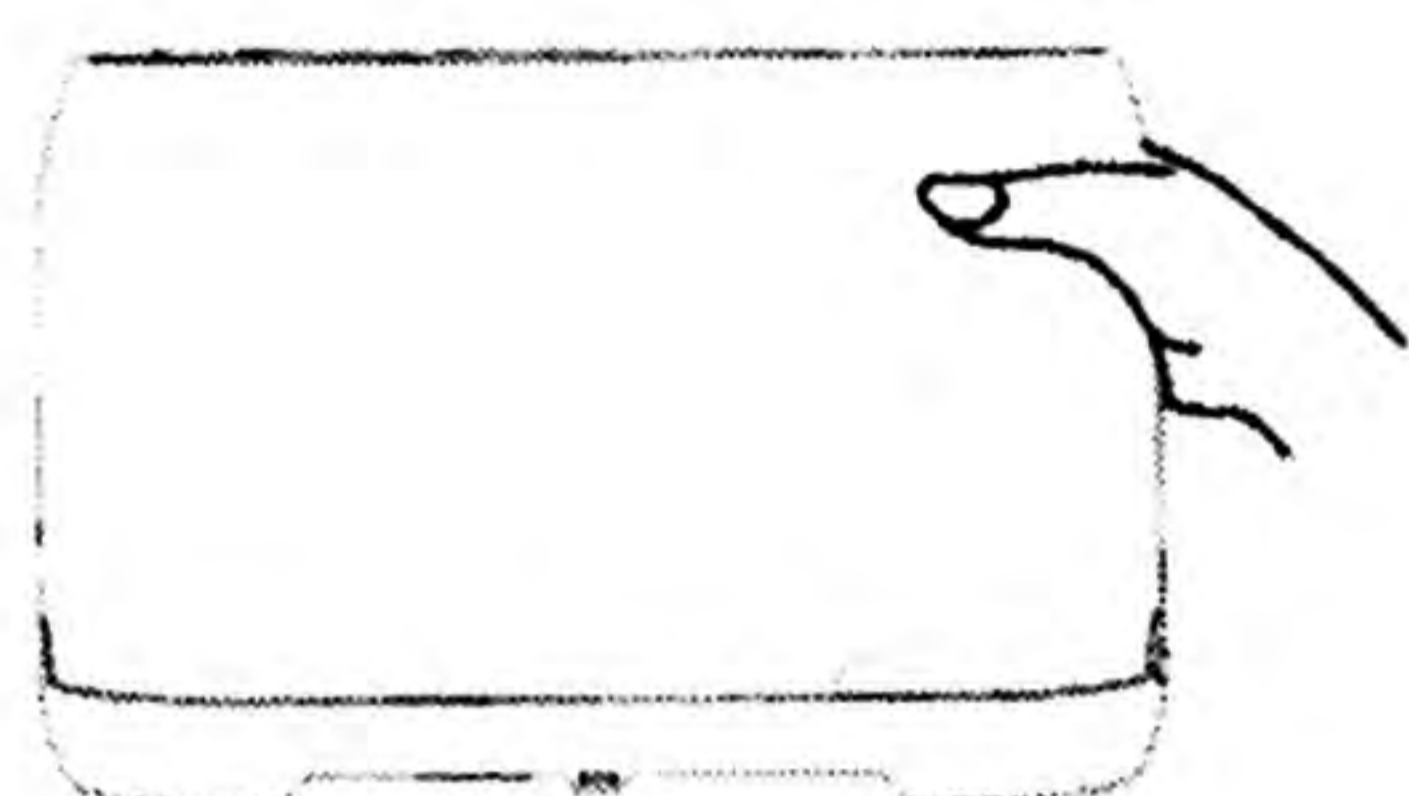

Fig4



Fig5



Fig6

Attention

- The amount and intensity of mist produced will vary, but this is not unusual and should not be considered as a fault.
- Factors that affect this include water type, humidity, temperature, air currents.
- Auto power off when water runs out.
- Applies only 100% natural essential oil, if they contain chemical ingredients, flavors or impurities may cause damage to the product.
- Before replacing another essential oil, follow the maintenance part to clean the product.

Accidental Leakage

In the event of the unit being knocked over or tipped during use, please follow the steps as below to avoid malfunction:

1. Unplug the unit and remove cover.
2. Pour out any remaining water from the water tank.
3. Shake the unit gently to drain water, and then keep it natural air drying for at least 24 hours.

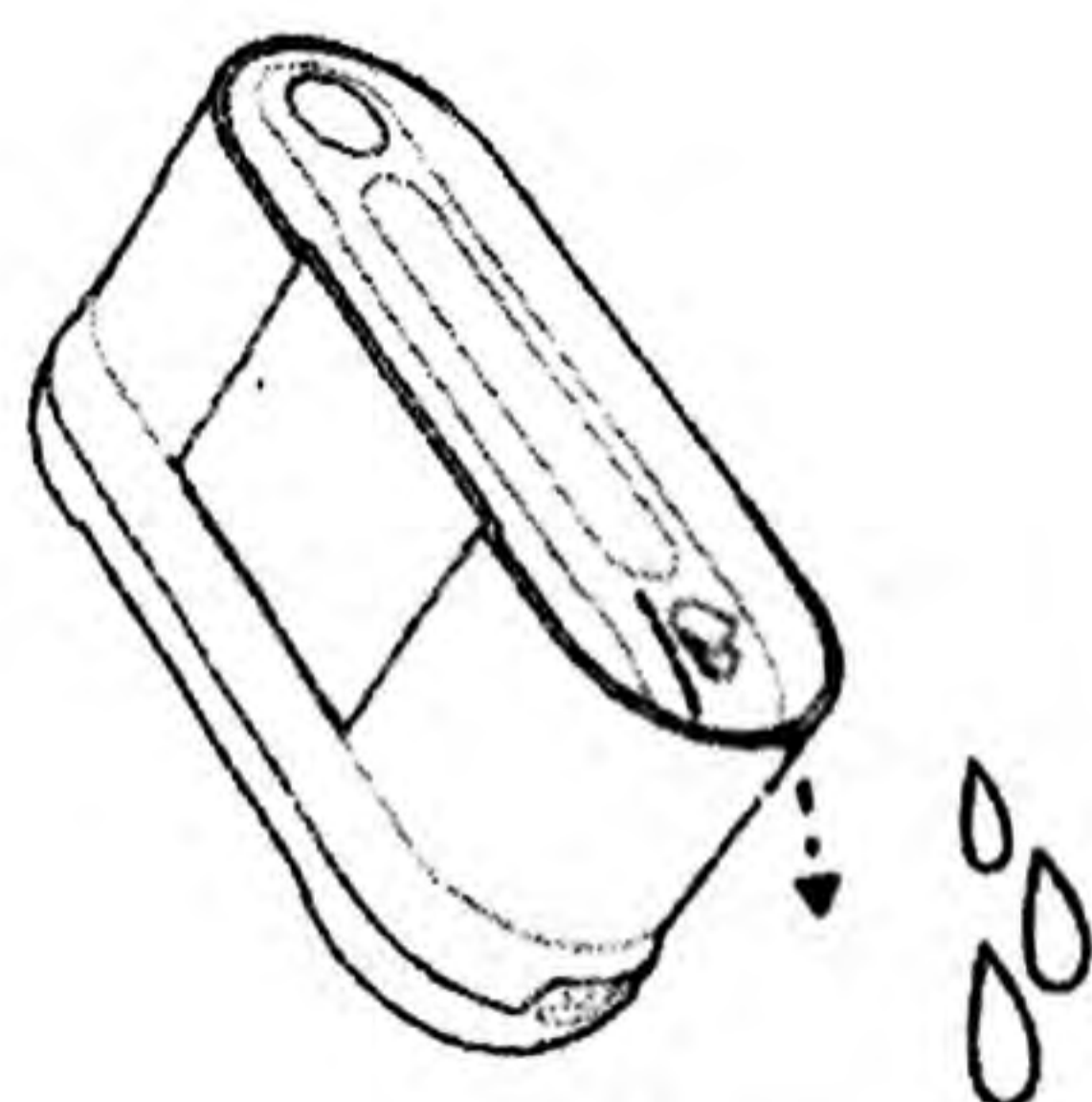

Maintenance

After using 5-6 times, or 3-5 days, please clean the product as follow:

1. Unplug the unit and remove cover.
2. Pour out any remaining water from the tank.
3. Add a small amount of warm kitchen detergent to clean, use swab to wipe it gently, and then use cleaning cloth to dry it lightly.
4. Refer to the following pictures, to avoid water flow into the air outlet, pour off water abide by the left picture, not the right one.
5. Do not use other acids or enzymes detergent, as this may give off poisonous gas or cause malfunction.

Note: Be sure to use a mild detergent.

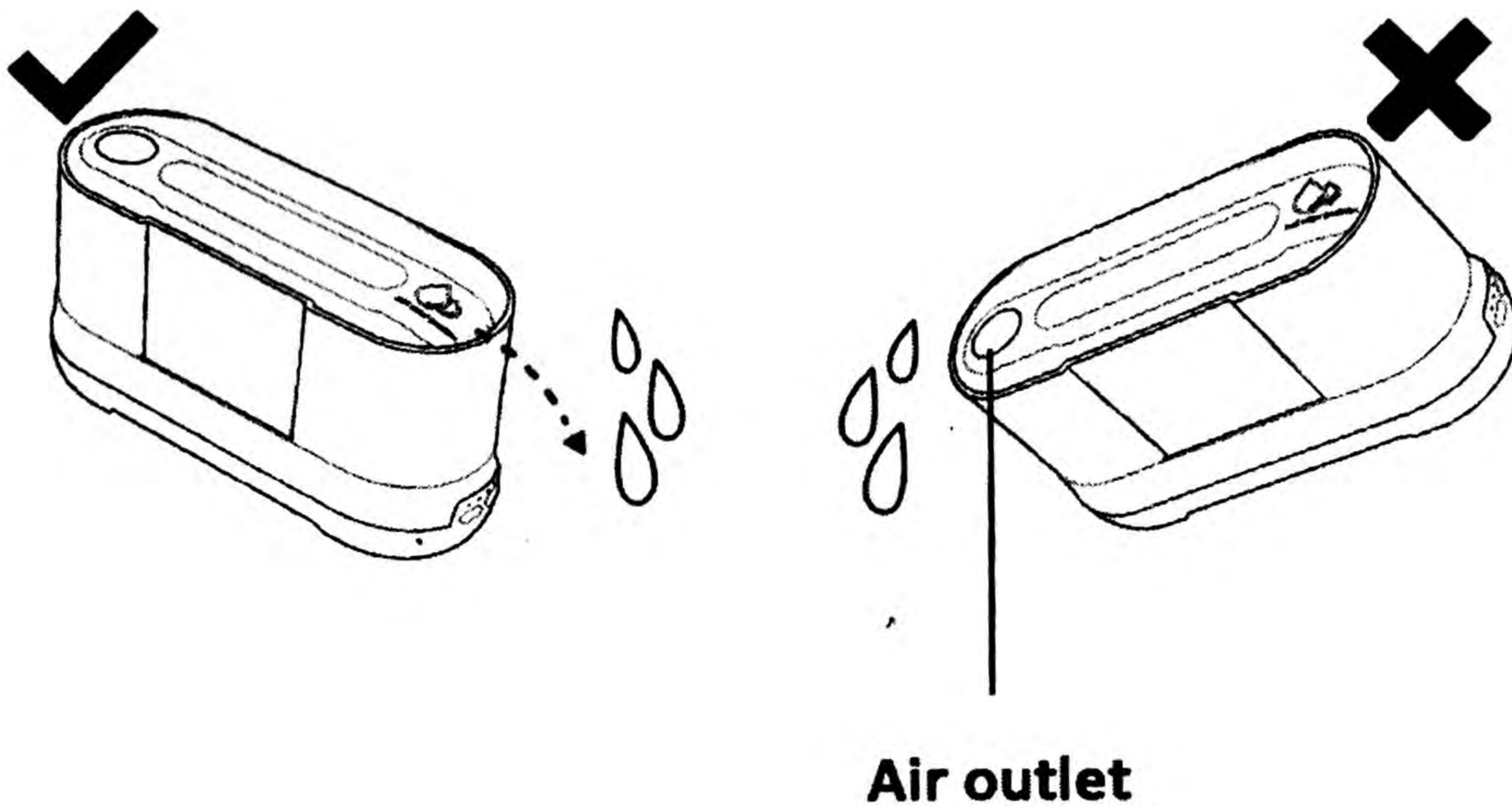

Precautions

- It is not allow to change, dismantle, or repair the unit if you are not the technician. Please contact the selling department to repair if necessary.
- Do not switch on power when the tank is empty.
- Do not touch the atomization piece.
- Clean regularly as per Maintenance instructions to avoid malfunction.
- Always unplug before maintenance.
- For hygiene reasons, after use, pour away remaining water from "DRAINAGE SIDE" of tank, and wipe with a clean dry cloth.
- Essential oil can corrode in the event of spillage of contact, please wipe away with a soft cloth.
- Only use the measuring cup to add water into the tank, do not fill water directly from the water pipe.
- Do not let mist directly to the furniture, clothing, walls etc.
- Keep away from direct sunshine heat sources and air conditioners or fans.
- Always keep on stable flat surface do not put on carpet, duvet or unstable area.
- Keep away from electronic equipment, such as TV and Audio equipment.
- Wait 60 minutes before restart to avoid damage atomization piece.
- Don't use sparkling water, tap water and mineral water are available.
- Never move product when it is working.
- Do not touch any part of the product with wet hands.
- Keep away from the child and pet, child is not allow to play without supervisor. This product is not suitable for the child and people who don't know the product and have no experience.
- If the cable is smoking, burning, unplug immediately.

Troubleshooting

Please refer to the table below in the event of the product operating abnormally:

If product doesn't work well, please refer to the following points before requesting repairs:	
Will not switch on or switch off	<ul style="list-style-type: none"> ● Is there enough water in the tank? --Please add water to the tank ● Is the power cord connected property? --Please disconnect, check cables and re-connect carefully.
No mist or abnormal mist	<ul style="list-style-type: none"> ● Not enough water? or too much water? --Please add suitable amount of water in the tank, water must never be filled over 400ML (MAX)line. ● Dirt on the atomization piece? --Please refer to maintenance instructions remove and re-install correctly, so mist can be released freely. ● Cover and inner cover are not installed properly? Dirt on the air suction port on the underside of the base? --If too much dust in the air suction port, the mist will be restricted to come out. Just clean it.
Water leakage from product	<ul style="list-style-type: none"> ● Cover and inner are not installed properly? --Remove and reinstall correctly, so mist can be released freely. ● Low temperature or high humidity? --Under these conditions, the mist may condense quickly into water droplets.

Specifications

Dimensions	201*80*138mm
Weight(excluding adaptor)	520g
Power: Input/Output	AC100-240V 50/60Hz DC24V 650mA
Length of cord	Approx 170CM
Power	Approx 14W
Tank Capacity	350ml
LED light	14 个 led 灯
Material	PP/ABS
Accessory	AC Adapter and manual
Working frequency	2.4MHz

App Connection Guide

Download TuyaSmart from App Store or Google Play. TuyaSmart



TuyaSmart

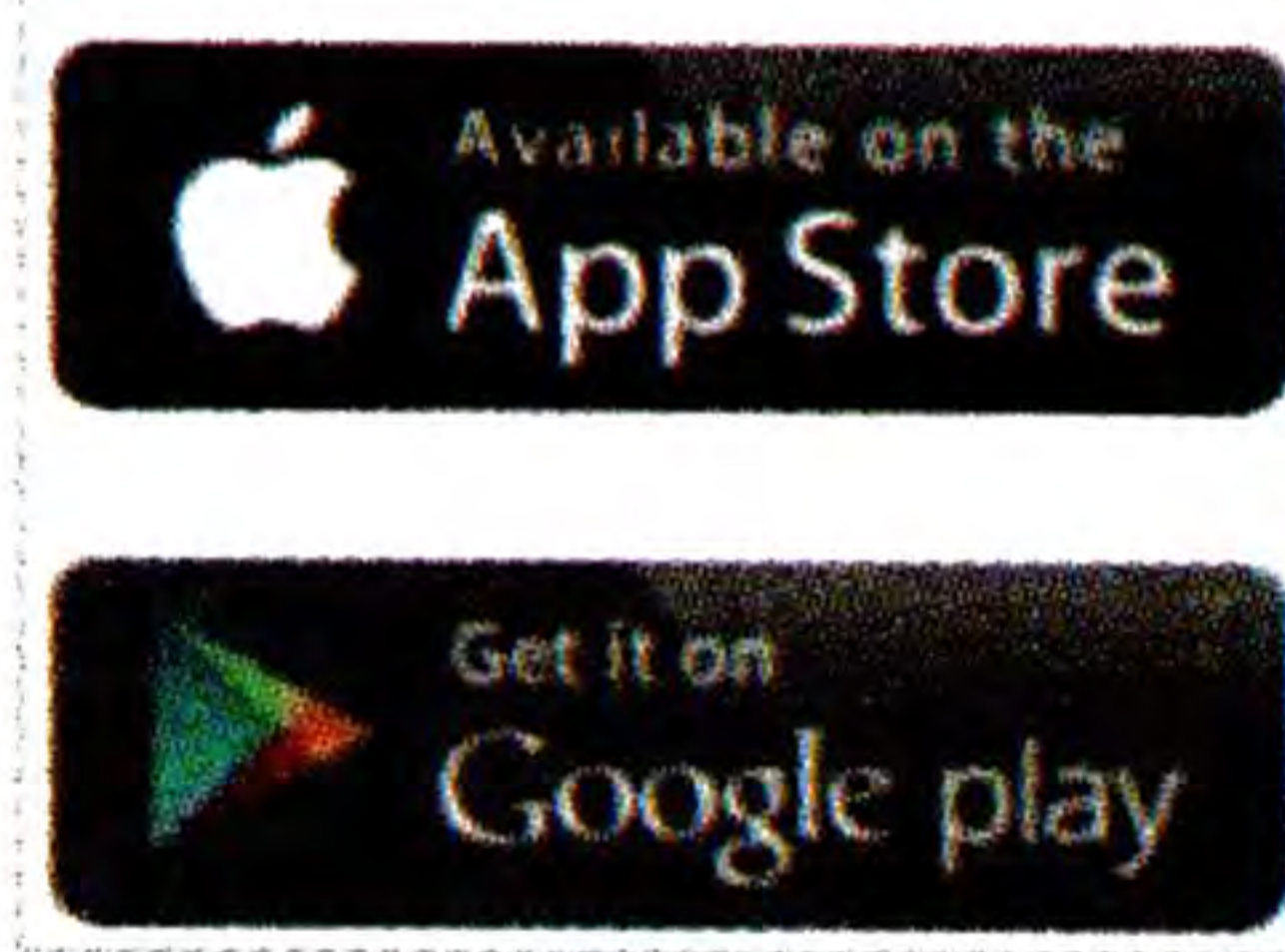

After downloading the APP, you can select the "Log In" option to register an account for login, or you can select the "Try now" option to directly use the APP. After that, You can enter the application interface and click Add to search for matching devices.

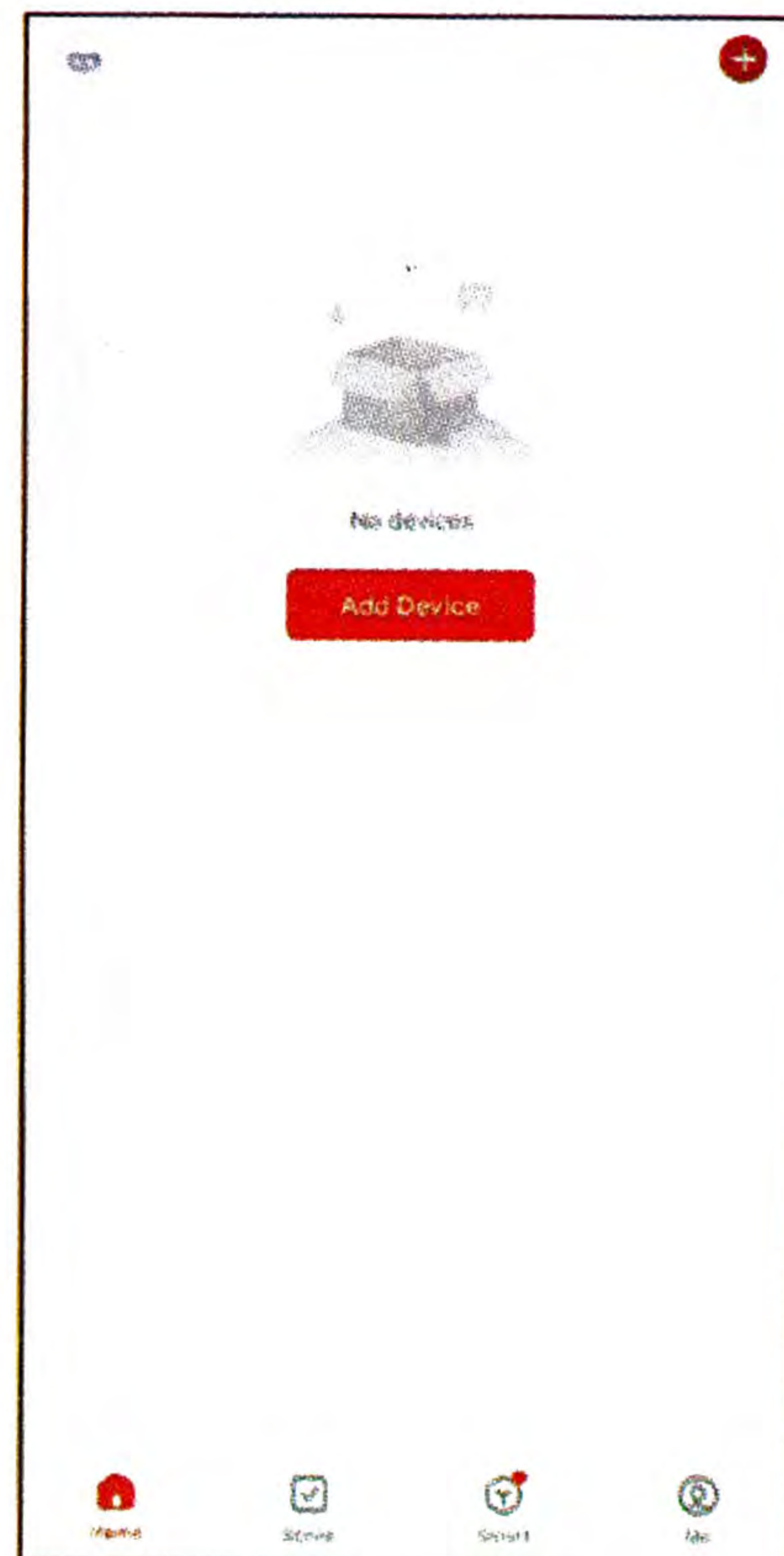
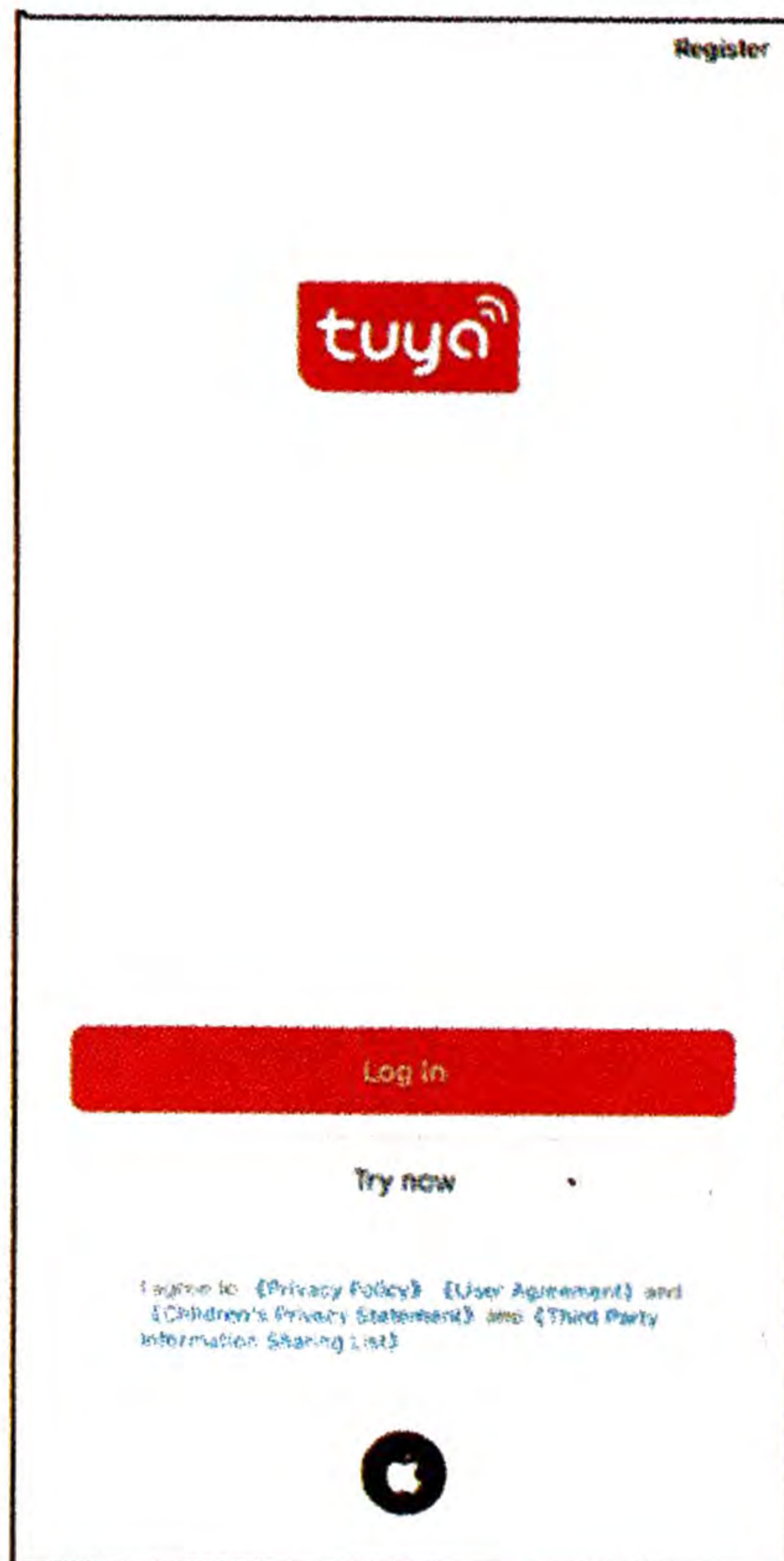

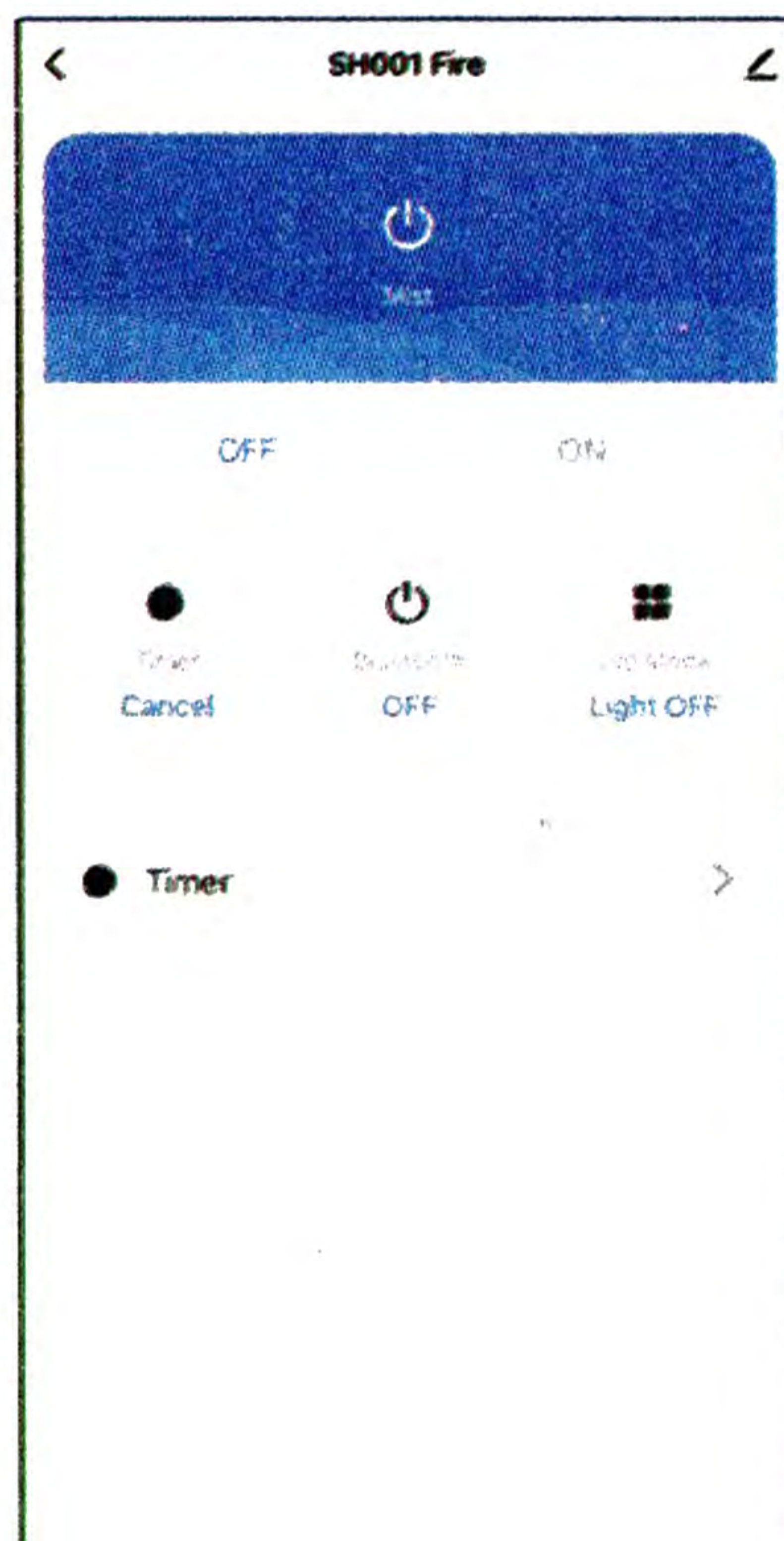
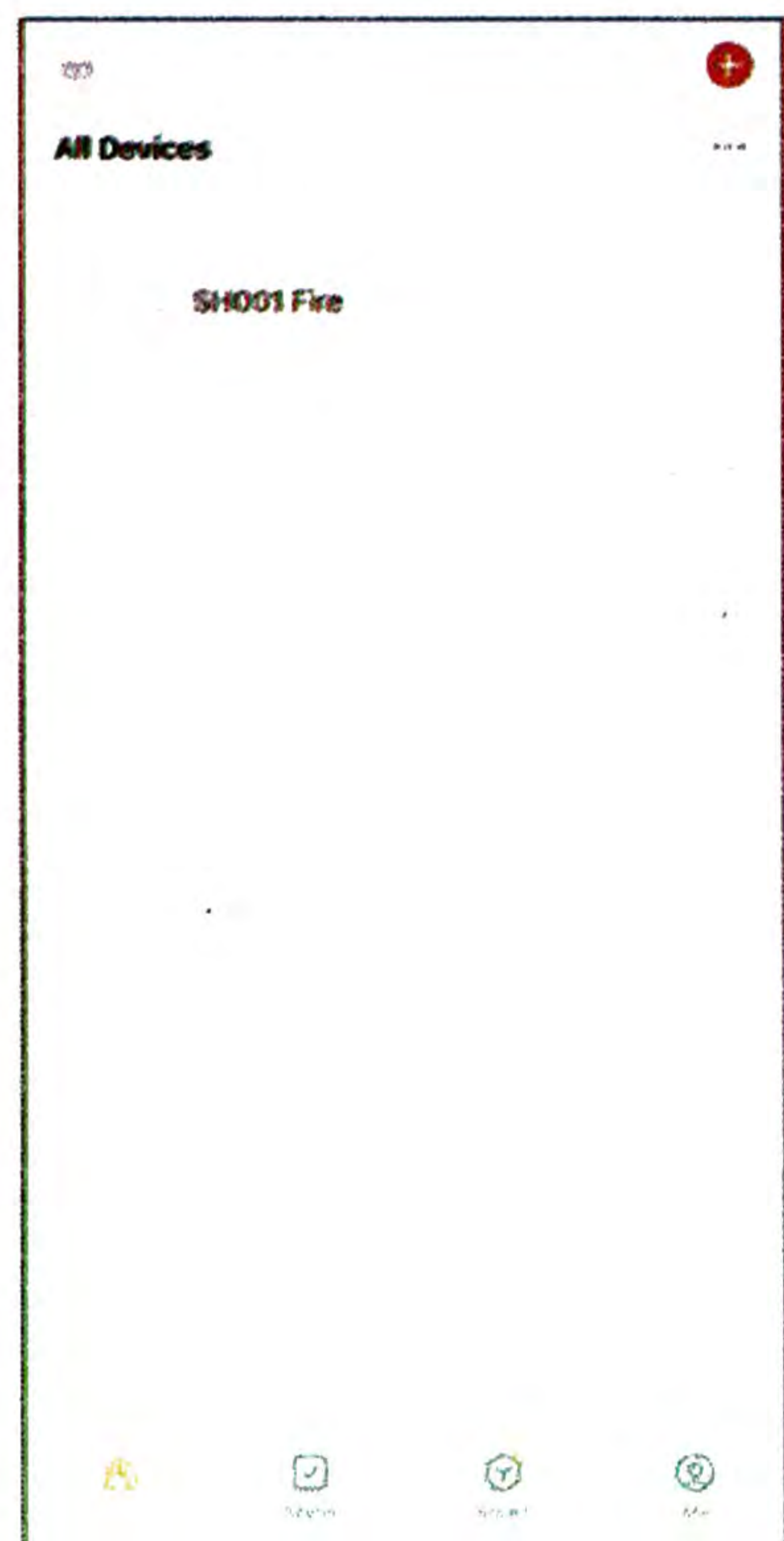
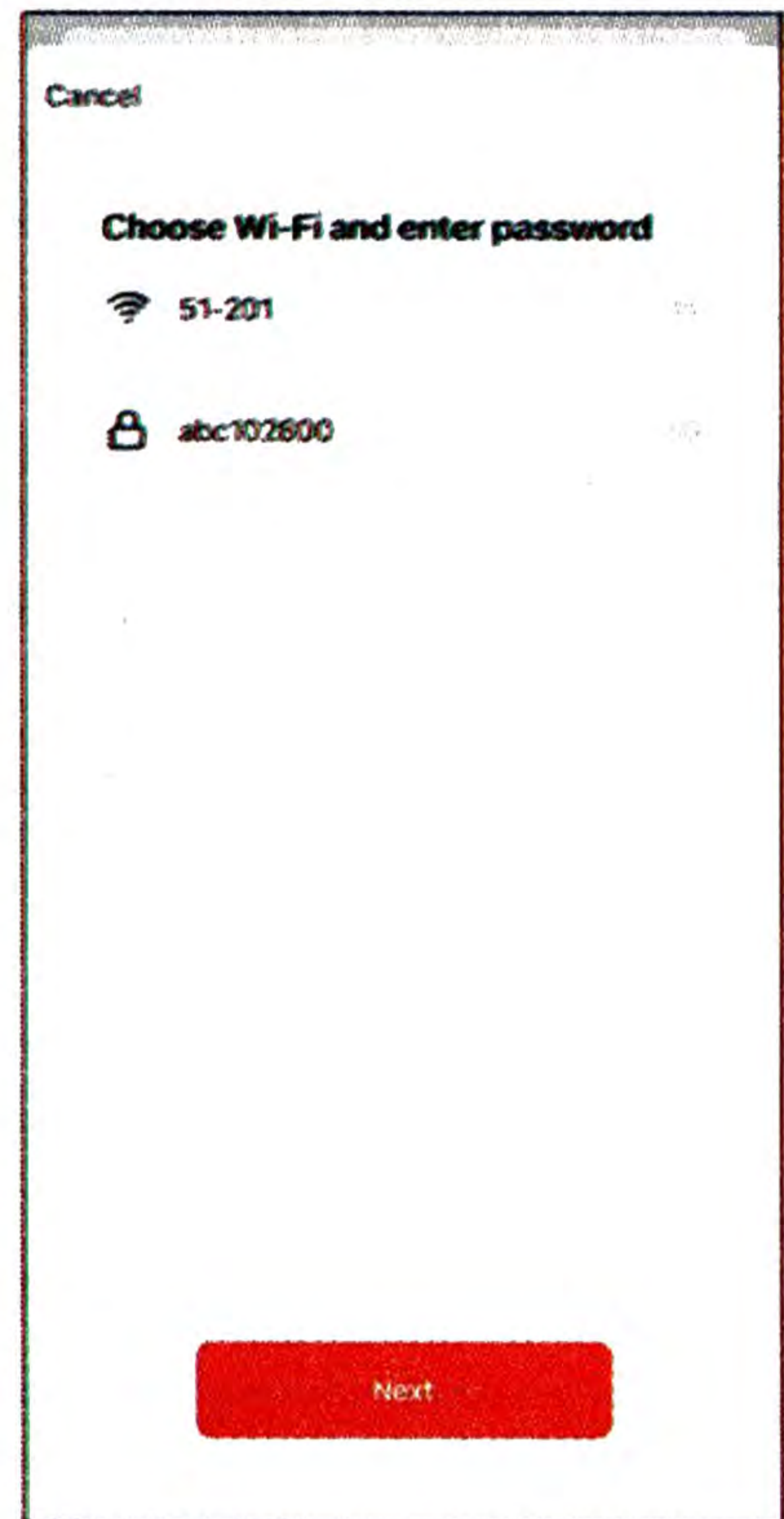
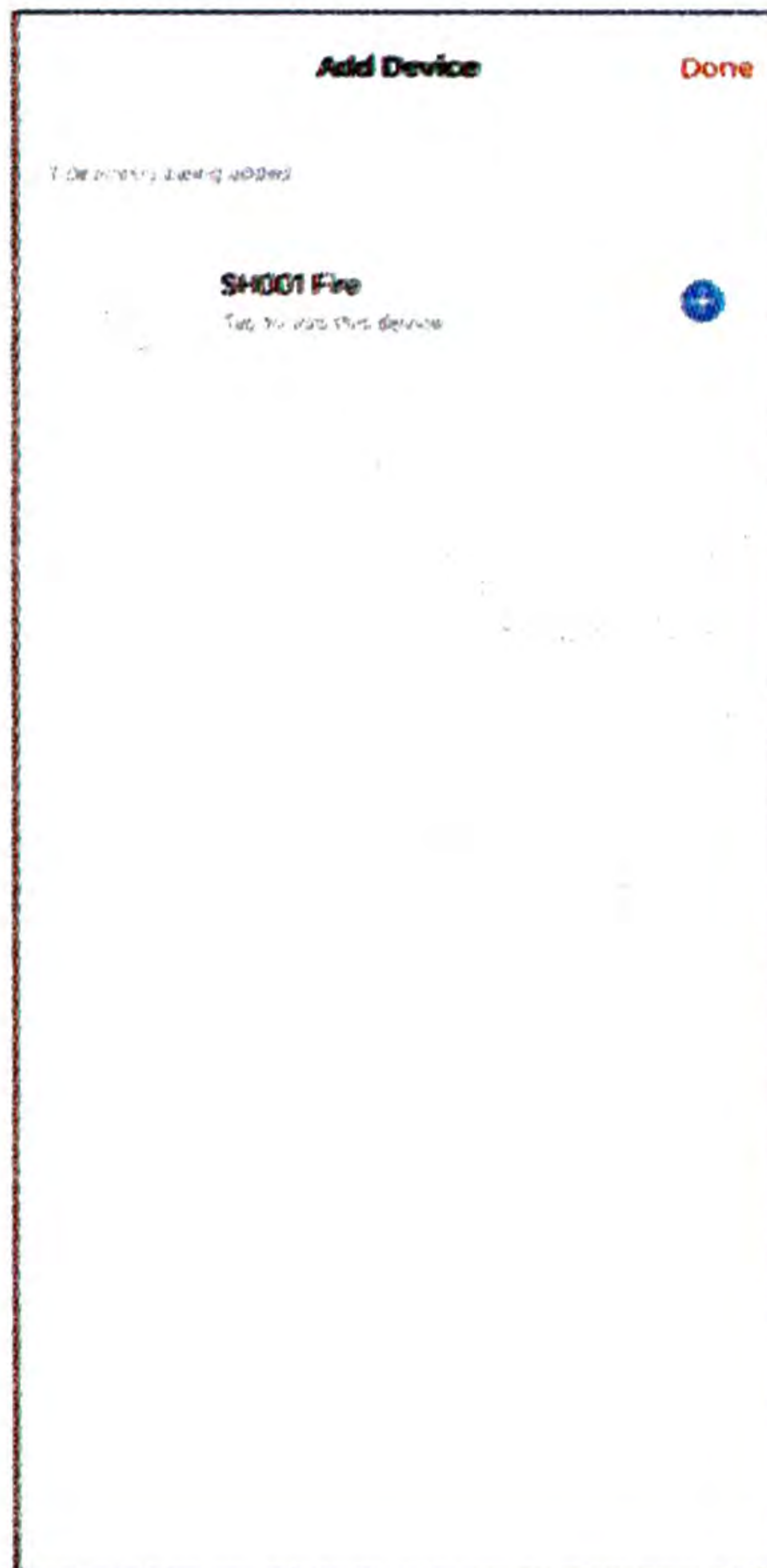
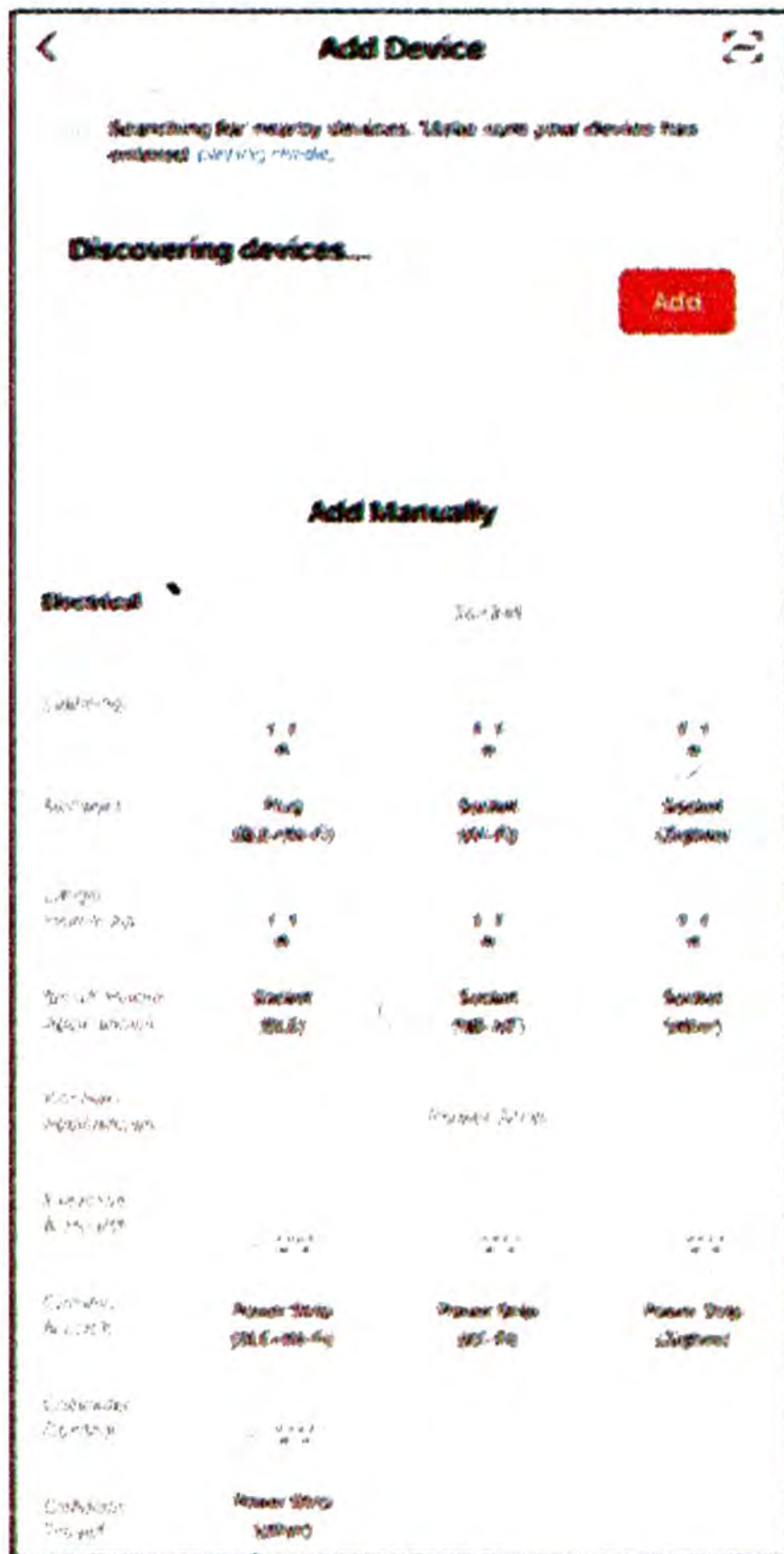

Click the detected device, click "+" to add the device, click "Next" by linking WIFI parallel devices, and then enter the control device page after linking the device. You can turn on the device through OFF, and control Bluetooth through "Cancel" timing, "OFF Bluetooth" timing, "LightOFF", and customize the timing "Timer" to control the device,

Note & QA

Note

- In order to pairing successfully, it's better to operate near the WIFI router. If your home Wi-Fi does not require a password, leave it blank.
- The device only supports 2.4GHz networks. 5GHz network is unavailable.
- If Failed to Add, please unplug the diffuser for 2 minutes and try again.

QA

Q: Router can not access the Internet, dose it support the local area network? Can it directly connect to cellphones hot spots?

A: The Android version supports LAN control, while Apple version currently not. The device must be connected to the Internet via a router to communicate with the mobile server.

Q: Why can not I get a registered SMS verification code? Why can not mobile phone connect device hotspot?

A: Permission is limited. Select "Allow" when you encounter authorization during installation.

Q: My router is 5GHz, but the diffuser only work with 2.4GHz, can I connect with this diffuser?

A: Yes, some routers will run dual band by default - both 5.0GHz and 2.4GHz.

In this case, there are two steps you need to do as follows:

- Disable 5.0 GHz frequency (temporarily)
- Set up a guest network

After doing both these things, the device will pair correctly and you can re-enable the 5.0GHz frequency without any other influence.